

LOW VOLTAGE VIDEO AMPLIFIER WITH LPF

■GENERAL DESCRIPTION

The **NJM2571A** is a Low Voltage Video Amplifier contained LPF circuit. Internal 75Ω driver is easy to connect TV monitor directly.

The **NJM2571A** features low power and small package, and is suitable for low power design on downsizing of DSC and DVC.

■PACKAGE OUTLINE



NJM2571AF1

■FEATURES

- Operating Voltage 2.8 to 5.5V
- 9dB amplifier
- Internal LPF -33dB at 19MHz typ.
- Internal 75Ω Driver Circuit (2-system drive)
- Power Save Circuit
- Bipolar Technology
- Package Outline MTP6

■BLOCK DIAGRAM

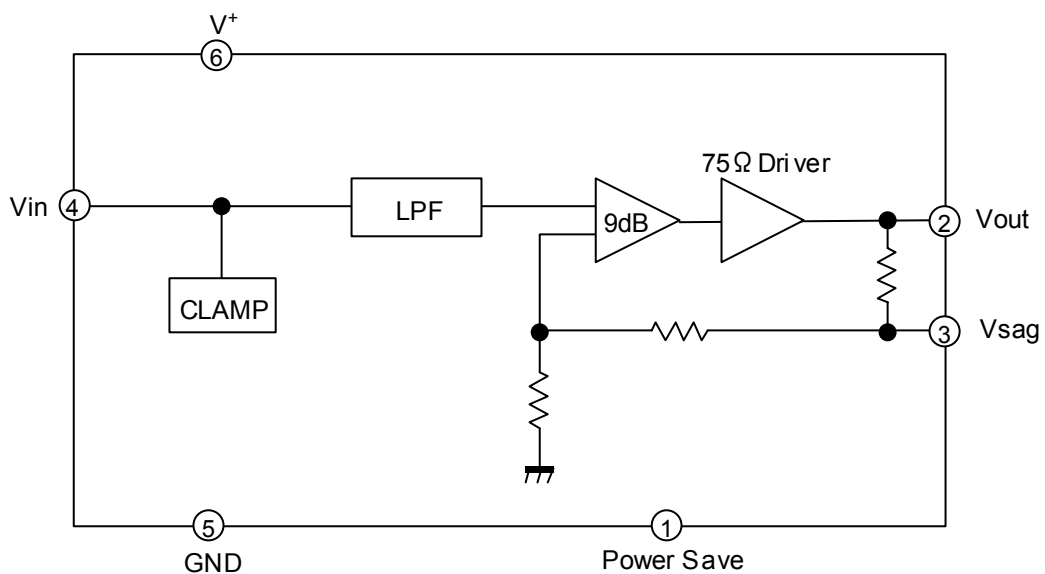

NJM2571A

■ABSOLUTE MAXIMUM RATINGS (Ta=25°C)

PARAMETER	SYMBOL	RATINGS	UNIT
Supply Voltage	V ⁺	7.0	V
Power Dissipation	P _D	200	mW
Operating Temperature Range	Topr	-40 to +85	°C
Storage Temperature Range	Tstg	-40 to +125	°C

■ELECTRICAL CHARACTERISTICS (V⁺=3.0V, R_L=150Ω, Ta=25°C)

PARAMETER	SYMBOL	TEST CONDITION	MIN.	TYP.	MAX.	UNIT
Operating Current	I _{CC}	No Signal	-	8.0	12.0	mA
Operating Current at Power Save	I _{save}	Power Save Mode	-	30	50	μA
Maximum Output Voltage Swing	V _{om}	f=100kHz, THD=1%	2.2	2.5	-	V _{p-p}
Voltage Gain	G _v	V _{in} =100kHz, 0.7V _{p-p} , Input Sine Signal	8.5	9.0	9.5	dB
Low Pass Filter Characteristic	G _{fy} 4.5M	V _{in} =4.5MHz/100kHz, 0.7V _{p-p}	-0.6	-0.1	0.4	dB
	G _{fy} 19M	V _{in} =19MHz/100kHz, 0.7V _{p-p}	-	-33	-23	
Differential Gain	DG	V _{in} =0.7V _{p-p} , Input 10step Video Signal	-	0.5	-	%
Differential Phase	DP	V _{in} =0.7V _{p-p} , Input 10step Video Signal	-	0.5	-	deg
S/N Ratio	SN _v	V _{in} =0.7V _{p-p} , R _L =75Ω 100% White Video Signal	-	+60	-	dB
2nd. Distortion	H _v	V _{in} =0.7V _{p-p} , 3.58MHz, Sine Video Signal, R _L =75Ω	-	-50	-	dB
SW Change Voltage High Level	V _{thPH}	Active	1.8	-	V ⁺	V
SW Change Voltage Low Level	V _{thPL}	Non-active	0	-	0.3	

■CONTROL TERMINAL

PARAMETER	STATUS	NOTE
Power Save	H	Power Save: OFF
	L	Power Save: ON
	OPEN	Power Save: ON

TEST CIRCUIT

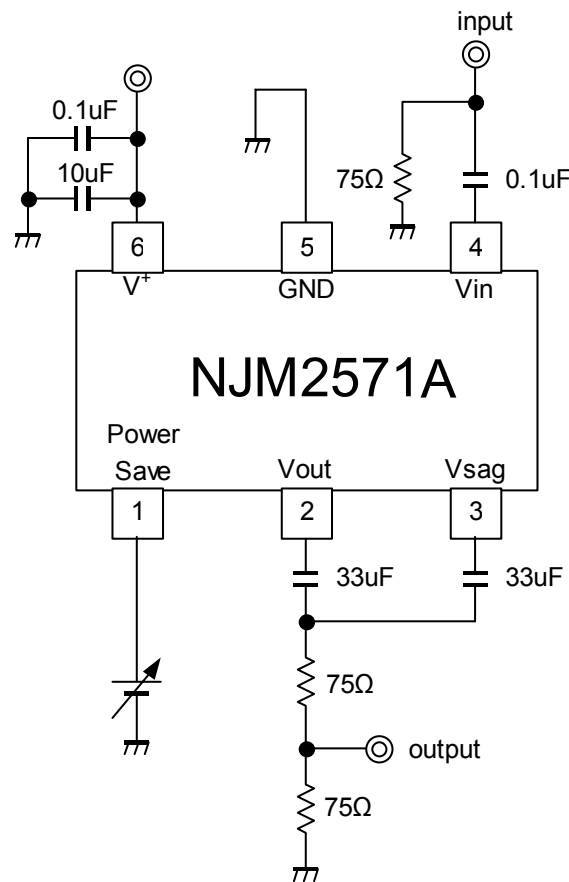

APPLICATION CIRCUIT

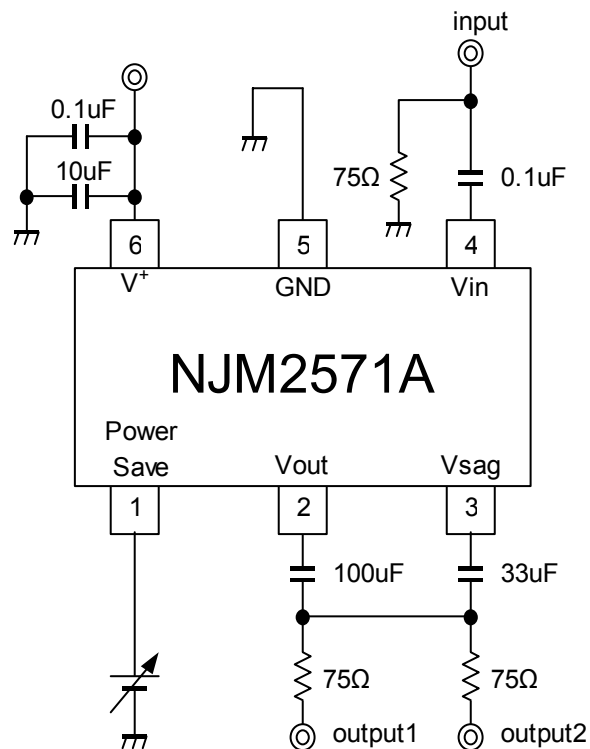

NJM2571A

■ TERMINAL FUNCTION

PIN No.	PIN NAME	DC VOLTAGE	EQUIVALENT CIRCUIT
1	Power Save	-	
2	Vout	0.26V	
3	Vsag	-	
4	Vin	1.10V	
5	GND	-	
6	V+	3V	

TYPICAL CHARACTERISTICS

Voltage Gain vs. Frequency

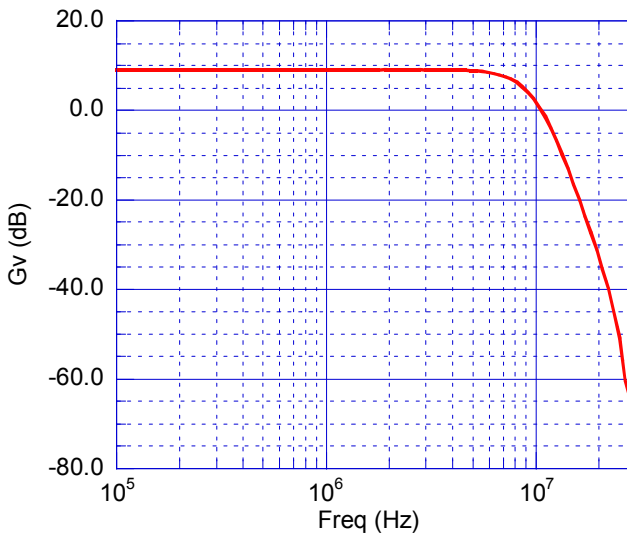

Operating Current vs. Supply Voltage

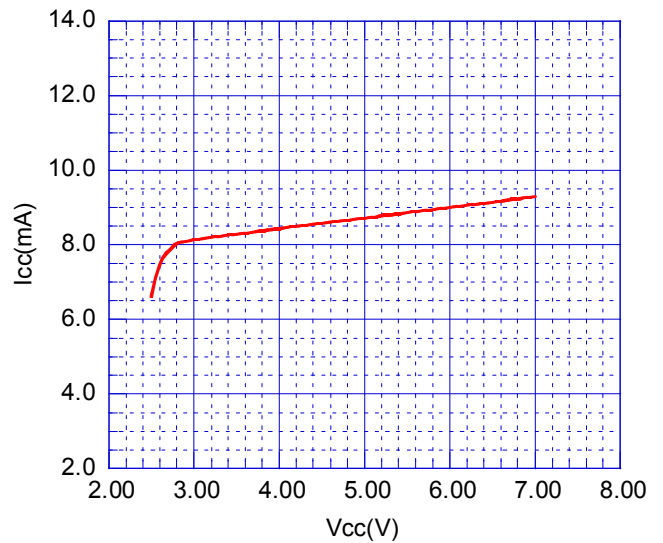

Operating Current at Standby State vs. Supply Voltage

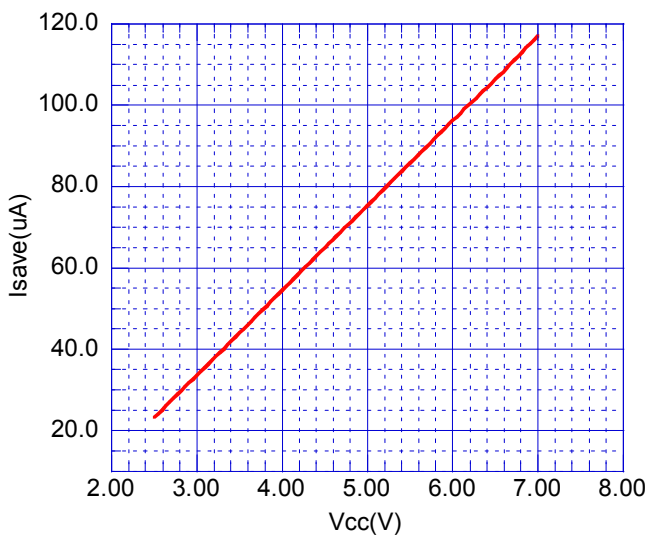

Maxim Output Voltage Swing vs. Supply Voltage

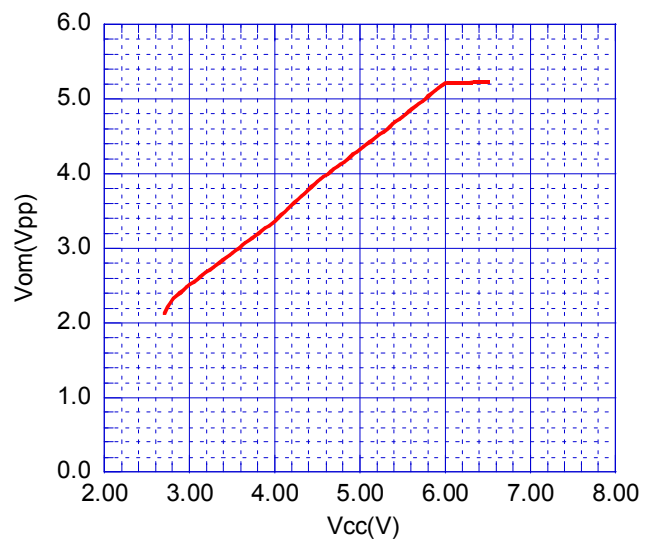

Voltage Gain vs. Supply Voltage

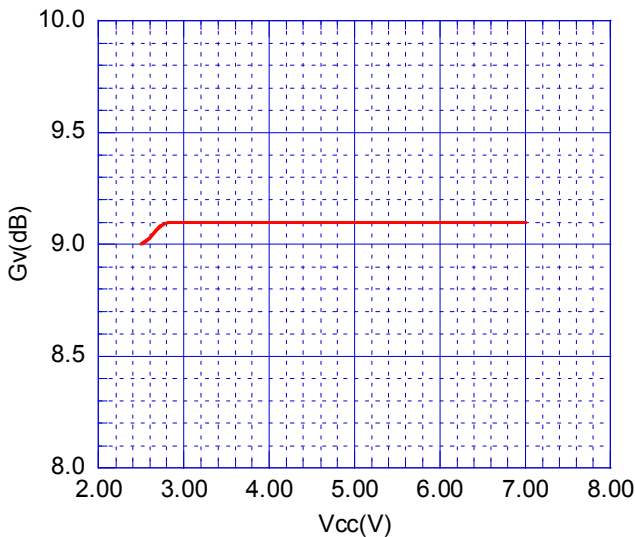

Low Pass Filter Characteristics vs. Supply Voltage
Gfy4.5M

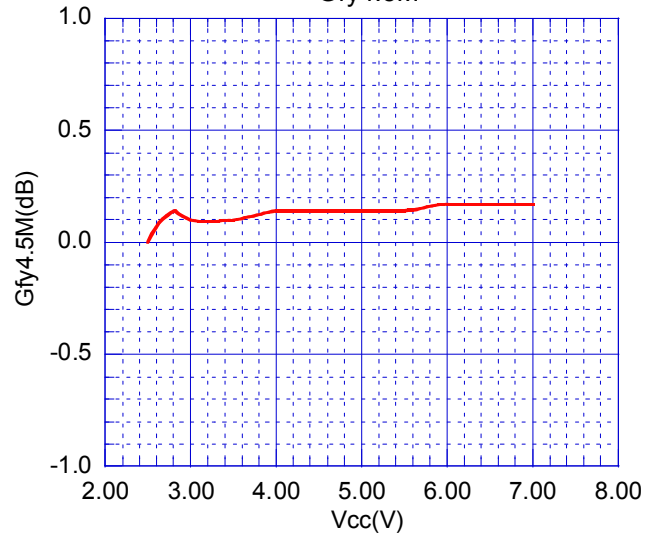

Low Pass Filter Characteristics vs. Supply Voltage
Gfy19M

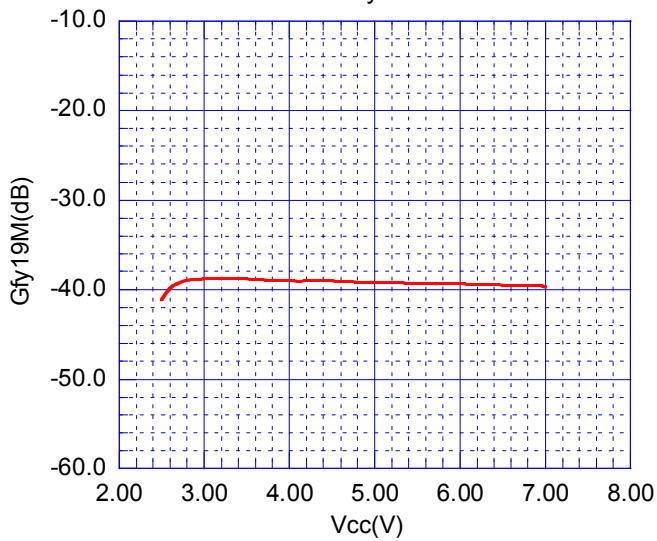

Differential Gain vs. Supply Voltage

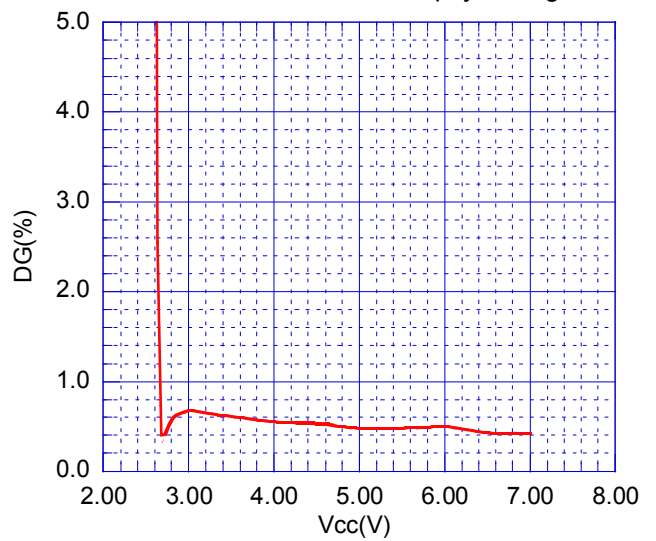

Differential Phase vs. Supply Voltage

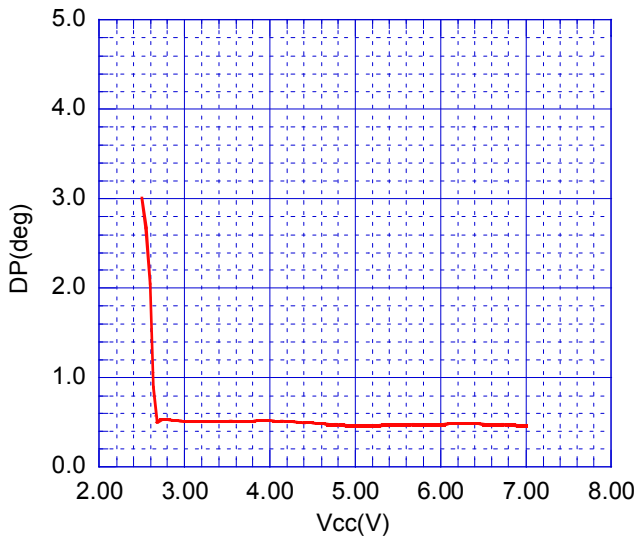

Signal to Noise Ratio vs. Supply Voltage

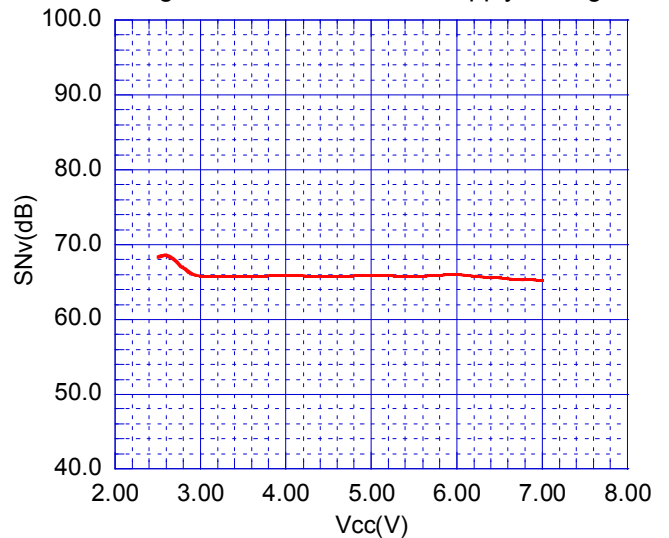

Second Harmonic Distortion vs. Supply Voltage

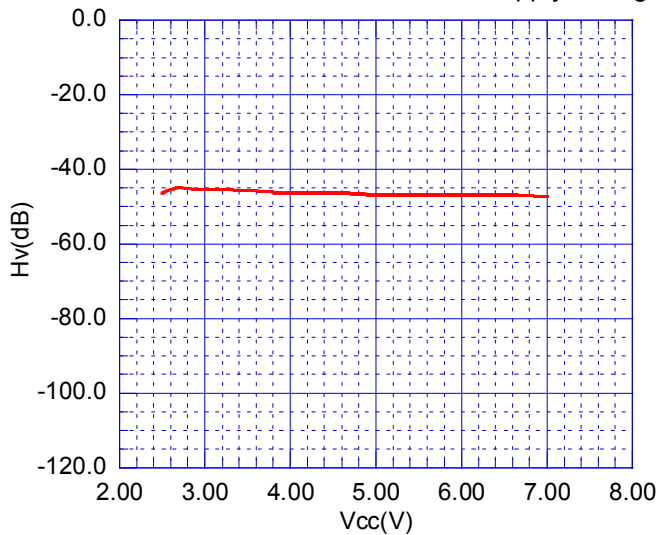

Switching Voltage vs. Supply Voltage

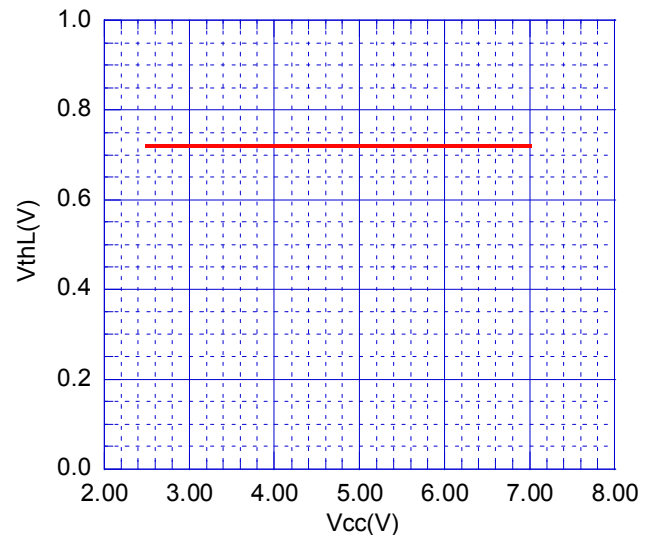

Switching Voltage vs. Supply Voltage

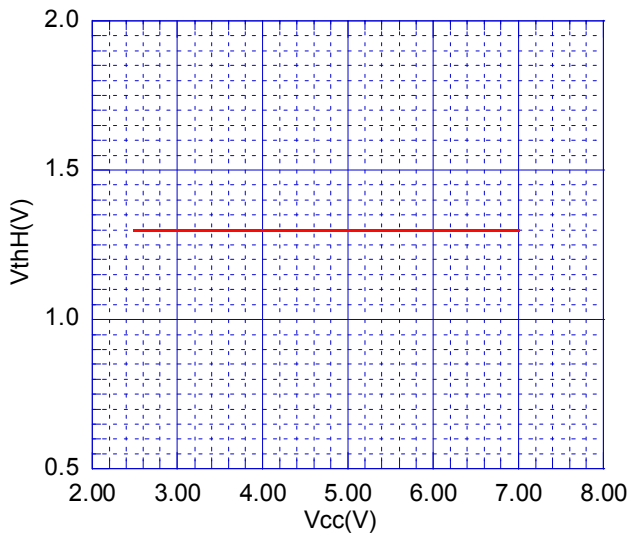

Operating Current vs. Temperature

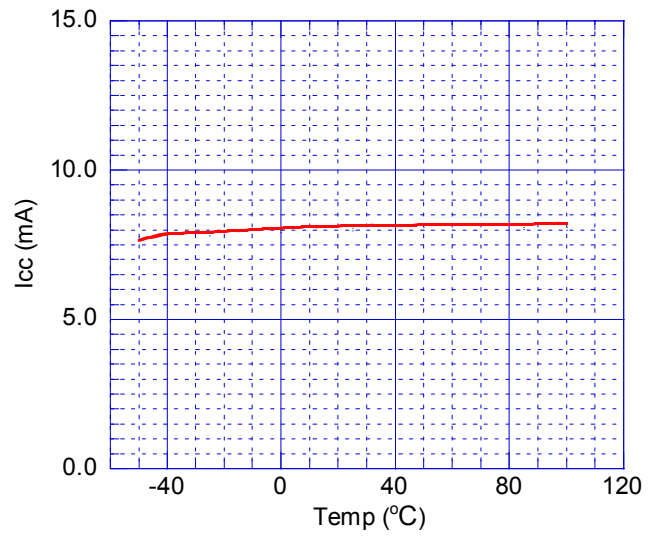

Operating Current at Standby State vs. Temperature

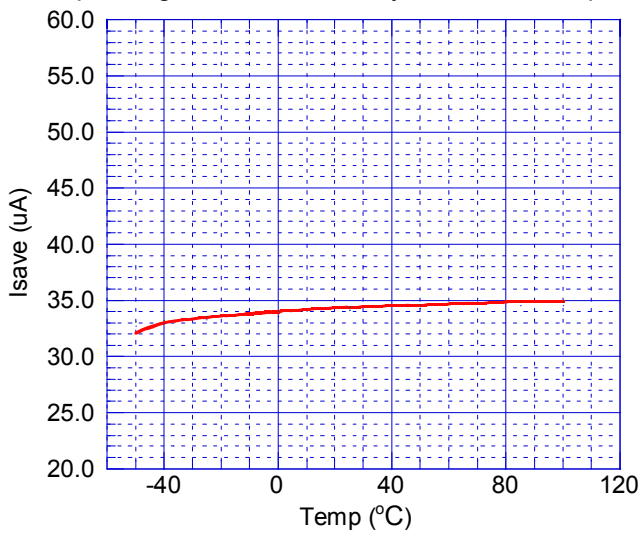

Maximum Output Voltage Swing vs. Temperature

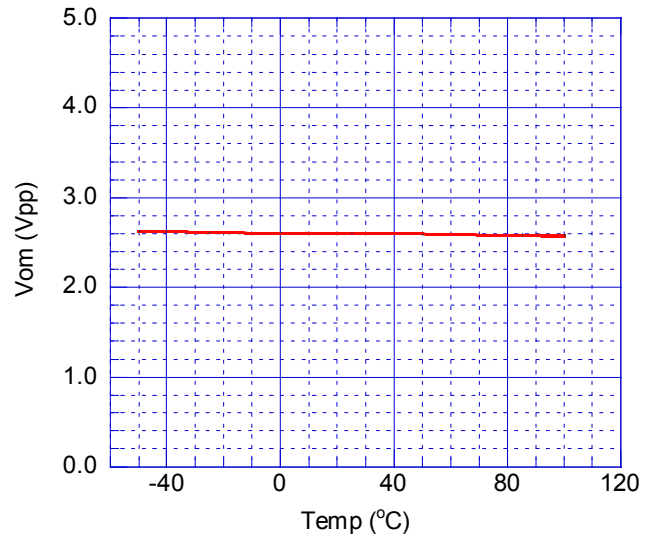

Voltage Gain vs. Temperature

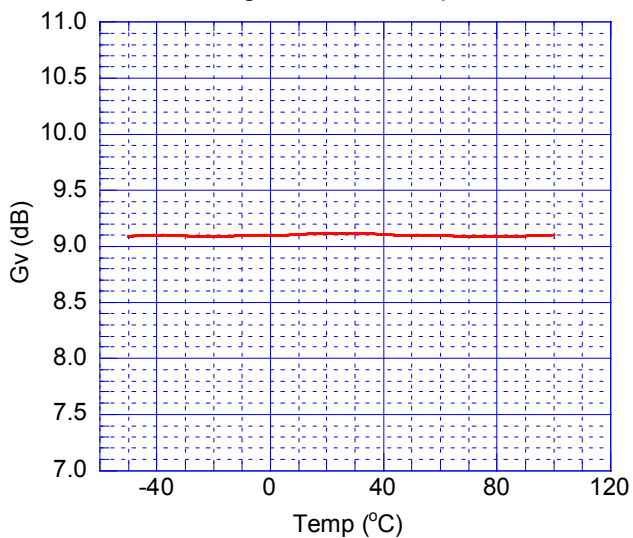

Low Pass Filter Characteristic vs. Temperature
Gfy4.5M

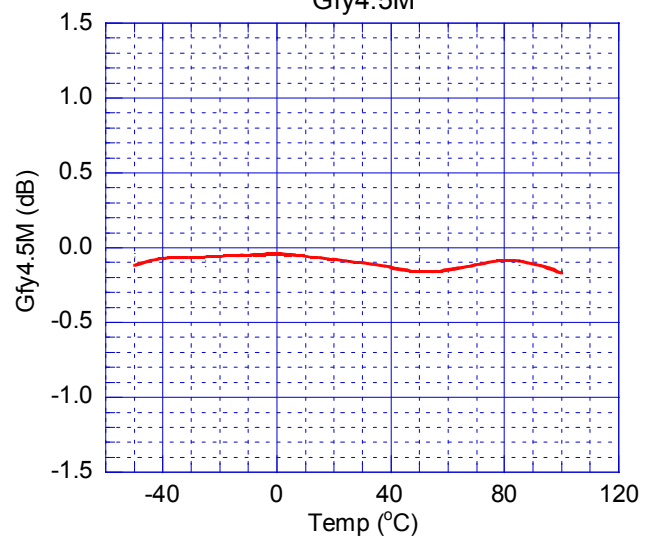

Low Pass Filter Characteristic vs. Temperature
Gfy19M

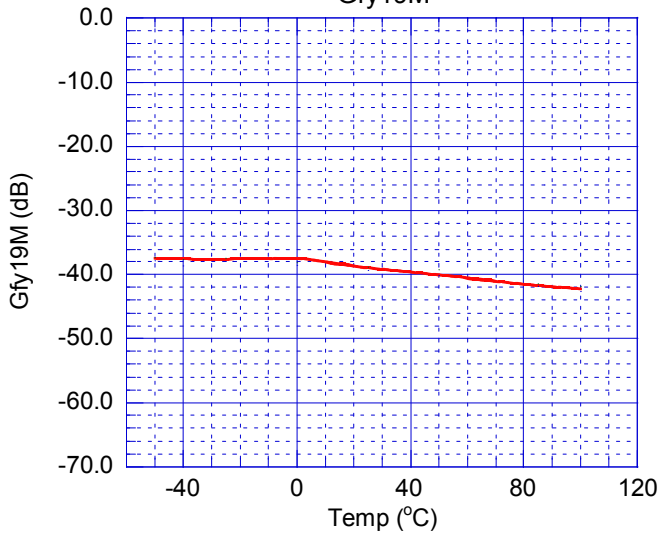

Differential Gain vs. Temperature

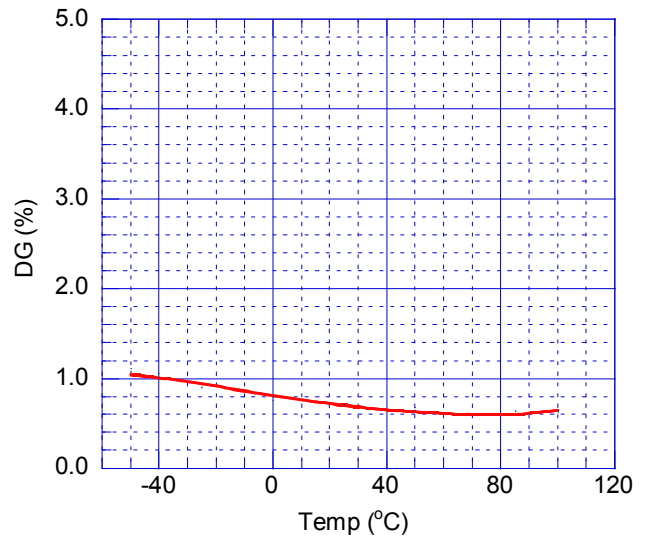

Differential Phase vs. Temperature

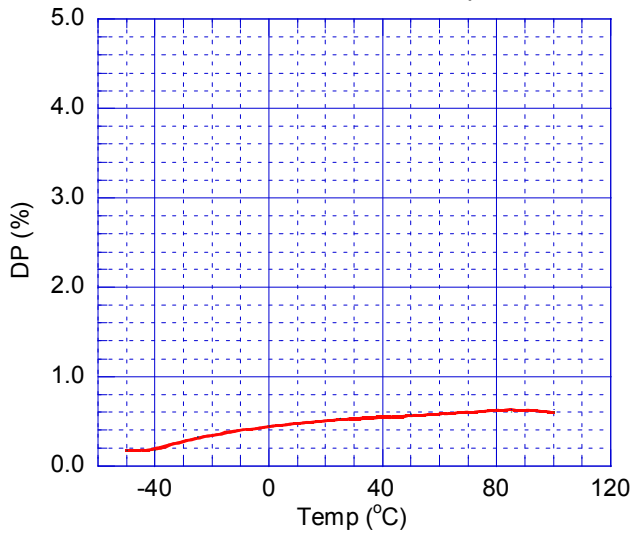

Signal to Noise Ratio vs. Temperature

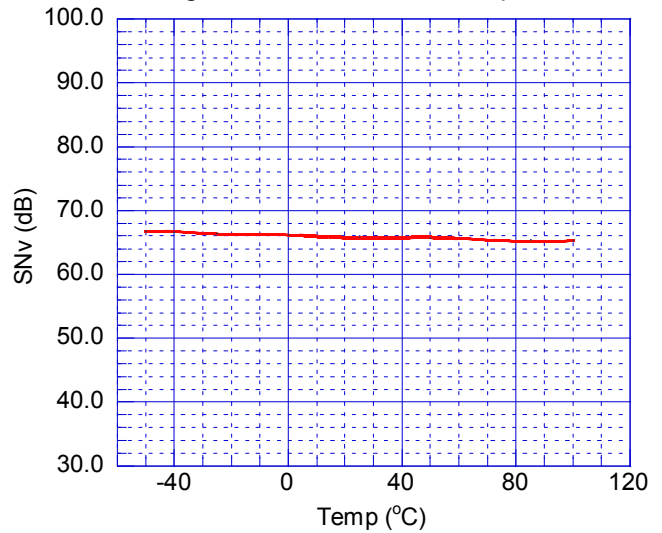

Second Harmonic Distortion vs. Temperature

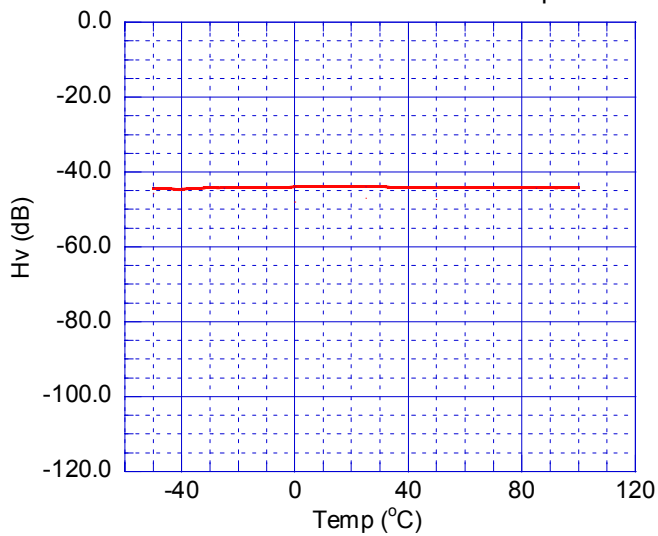

Switching Voltage vs. Temperature

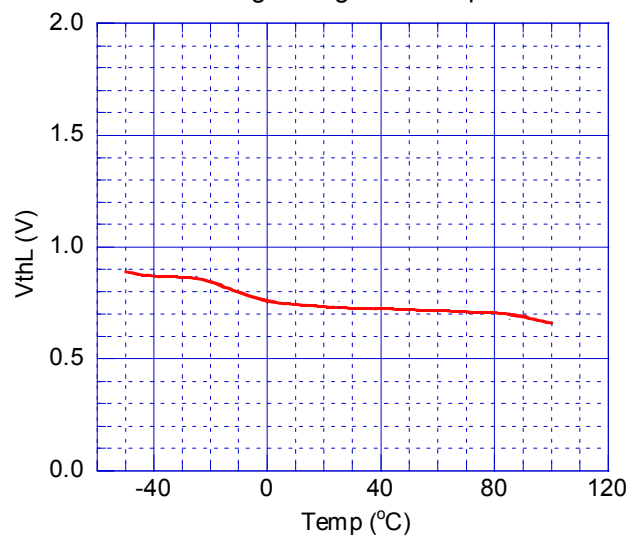

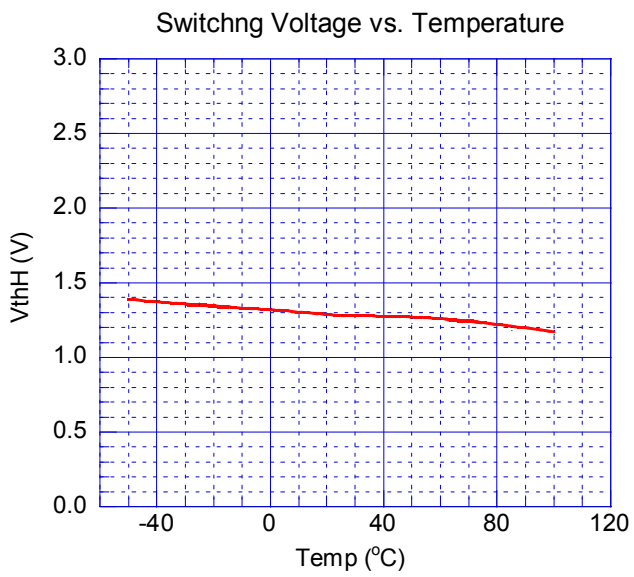

[CAUTION]
 The specifications on this databook are only given for information, without any guarantee as regards either mistakes or omissions. The application circuits in this databook are described only to show representative usages of the product and not intended for the guarantee or permission of any right including the industrial rights.